

RF LDMOS Wideband Integrated Power Amplifier

The MMRF2004NB wideband integrated circuit is designed with on-chip matching that makes it usable from 2300 to 2700 MHz. This multi-stage structure is rated for 26 to 32 V operation and covers all typical cellular base station modulation formats.

- Typical WiMAX Performance: $V_{DD} = 28$ Vdc, $I_{DQ1} = 77$ mA, $I_{DQ2} = 275$ mA, $P_{out} = 4$ W Avg., $f = 2700$ MHz, OFDM 802.16d, 64 QAM $^{3/4}$, 4 Bursts, 10 MHz Channel Bandwidth, Input Signal PAR = 9.5 dB @ 0.01% Probability on CCDF.
Power Gain — 28.5 dB
Power Added Efficiency — 17%
Device Output Signal PAR — 9 dB @ 0.01% Probability on CCDF
ACPR @ 8.5 MHz Offset — -50 dBc in 1 MHz Channel Bandwidth

Driver Applications

- Typical WiMAX Performance: $V_{DD} = 28$ Vdc, $I_{DQ1} = 77$ mA, $I_{DQ2} = 275$ mA, $P_{out} = 26$ dBm Avg., $f = 2700$ MHz, OFDM 802.16d, 64 QAM $^{3/4}$, 4 Bursts, 10 MHz Channel Bandwidth, Input Signal PAR = 9.5 dB @ 0.01% Probability on CCDF.
Power Gain — 27.8 dB
Power Added Efficiency — 3.2%
Device Output Signal PAR — 9 dB @ 0.01% Probability on CCDF
ACPR @ 8.5 MHz Offset — -56 dBc in 1 MHz Channel Bandwidth
- Capable of Handling 10:1 VSWR, @ 32 Vdc, 2600 MHz, 40 W CW Output Power (3 dB Input Overdrive from Rated P_{out})
- Stable into a 5:1 VSWR. All Spurs Below -60 dBc @ 100 mW to 5 W CW P_{out}
- Typical P_{out} @ 1 dB Compression Point ≈ 25 W CW

Features

- 100% PAR Tested for Guaranteed Output Power Capability
- Characterized with Series Equivalent Large-Signal Impedance Parameters and Common Source S-Parameters
- On-Chip Matching (50 Ohm Input, DC Blocked)
- Integrated Quiescent Current Temperature Compensation with Enable/Disable Function (1)
- Integrated ESD Protection
- 225°C Capable Plastic Package
- In Tape and Reel. R1 Suffix = 500 Units, 44 mm Tape Width, 13-inch Reel.

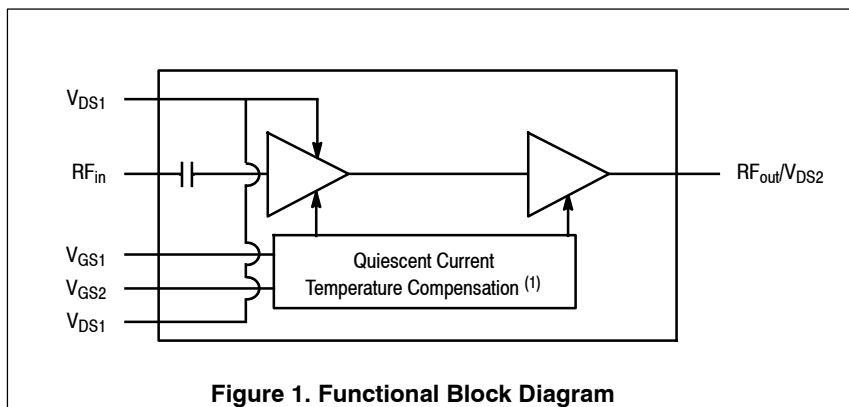
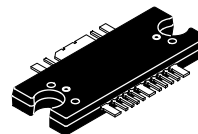

Figure 1. Functional Block Diagram

1. Refer to AN1977, *Quiescent Current Thermal Tracking Circuit in the RF Integrated Circuit Family* and to AN1987, *Quiescent Current Control for the RF Integrated Circuit Device Family*. Go to <http://www.freescale.com/rf>. Select Documentation/Application Notes - AN1977 or AN1987.

MMRF2004NBR1

2500-2700 MHz, 4 W AVG., 28 V
WiMAX
RF LDMOS WIDEBAND
INTEGRATED POWER AMPLIFIER



TO-272WB-16
PLASTIC

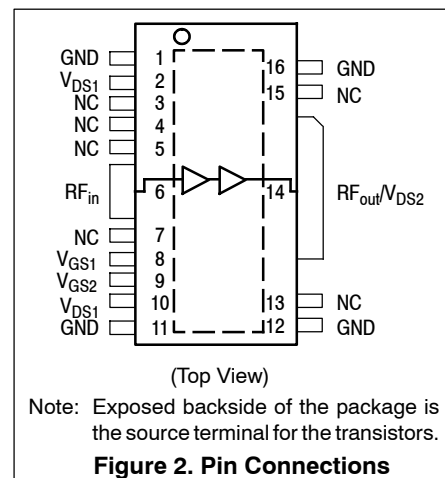

Figure 2. Pin Connections

Table 1. Maximum Ratings

Rating	Symbol	Value	Unit
Drain-Source Voltage	V_{DS}	-0.5, +65	Vdc
Gate-Source Voltage	V_{GS}	-0.5, +10	Vdc
Operating Voltage	V_{DD}	32, +0	Vdc
Storage Temperature Range	T_{stg}	- 65 to +150	°C
Case Operating Temperature	T_C	150	°C
Operating Junction Temperature (1)	T_J	225	°C
Input Power	P_{in}	22	dBm

Table 2. Thermal Characteristics

Characteristic	Symbol	Value (2)	Unit
Thermal Resistance, Junction to Case	$R_{\theta JC}$		°C/W
WiMAX Application (Case Temperature 75°C, $P_{out} = 4$ W Avg.)		Stage 1, 28 Vdc, $I_{DQ1} = 77$ mA Stage 2, 28 Vdc, $I_{DQ2} = 275$ mA	5.9 1.4
CW Application (Case Temperature 81°C, $P_{out} = 25$ W CW)		Stage 1, 28 Vdc, $I_{DQ1} = 77$ mA Stage 2, 28 Vdc, $I_{DQ2} = 275$ mA	5.5 1.3

Table 3. ESD Protection Characteristics

Test Methodology	Class
Human Body Model (per JESD22-A114)	1B
Machine Model (per EIA/JESD22-A115)	A
Charge Device Model (per JESD22-C101)	II

Table 4. Moisture Sensitivity Level

Test Methodology	Rating	Package Peak Temperature	Unit
Per JESD22-A113, IPC/JEDEC J-STD-020	3	260	°C

Table 5. Electrical Characteristics ($T_A = 25^\circ\text{C}$ unless otherwise noted)

Characteristic	Symbol	Min	Typ	Max	Unit
Stage 1 - Off Characteristics					
Zero Gate Voltage Drain Leakage Current ($V_{DS} = 65$ Vdc, $V_{GS} = 0$ Vdc)	I_{DSS}	—	—	10	μAdc
Zero Gate Voltage Drain Leakage Current ($V_{DS} = 28$ Vdc, $V_{GS} = 0$ Vdc)	I_{DSS}	—	—	1	μAdc
Gate-Source Leakage Current ($V_{GS} = 1.5$ Vdc, $V_{DS} = 0$ Vdc)	I_{GSS}	—	—	1	μAdc
Stage 1 - On Characteristics					
Gate Threshold Voltage ($V_{DS} = 10$ Vdc, $I_D = 20$ μAdc)	$V_{GS(th)}$	1.2	1.9	2.7	Vdc
Gate Quiescent Voltage ($V_{DS} = 28$ Vdc, $I_{DQ1} = 77$ mA)	$V_{GS(Q)}$	—	2.7	—	Vdc
Fixture Gate Quiescent Voltage ($V_{DD} = 28$ Vdc, $I_{DQ1} = 77$ mA, Measured in Functional Test)	$V_{GG(Q)}$	12.5	15.8	19.5	Vdc

1. Continuous use at maximum temperature will affect MTTF.
2. Refer to AN1955, *Thermal Measurement Methodology of RF Power Amplifiers*. Go to <http://www.freescale.com/rf>. Select Documentation/Application Notes - AN1955.

(continued)

Table 5. Electrical Characteristics ($T_A = 25^\circ\text{C}$ unless otherwise noted) (continued)

Characteristic	Symbol	Min	Typ	Max	Unit
Stage 2 - Off Characteristics					
Zero Gate Voltage Drain Leakage Current ($V_{DS} = 65\text{ Vdc}$, $V_{GS} = 0\text{ Vdc}$)	I_{DSS}	—	—	10	$\mu\text{A dc}$
Zero Gate Voltage Drain Leakage Current ($V_{DS} = 28\text{ Vdc}$, $V_{GS} = 0\text{ Vdc}$)	I_{DSS}	—	—	1	$\mu\text{A dc}$
Gate-Source Leakage Current ($V_{GS} = 1.5\text{ Vdc}$, $V_{DS} = 0\text{ Vdc}$)	I_{GSS}	—	—	1	$\mu\text{A dc}$

Stage 2 - On Characteristics

Gate Threshold Voltage ($V_{DS} = 10\text{ Vdc}$, $I_D = 80\ \mu\text{A dc}$)	$V_{GS(th)}$	1.2	1.9	2.7	Vdc
Gate Quiescent Voltage ($V_{DS} = 28\text{ Vdc}$, $I_{DQ2} = 275\text{ mA dc}$)	$V_{GS(Q)}$	—	2.7	—	Vdc
Fixture Gate Quiescent Voltage ($V_{DD} = 28\text{ Vdc}$, $I_{DQ2} = 275\text{ mA dc}$, Measured in Functional Test)	$V_{GG(Q)}$	11	14	18	Vdc
Drain-Source On-Voltage ($V_{GS} = 10\text{ Vdc}$, $I_D = 800\text{ mA dc}$)	$V_{DS(on)}$	0.15	0.47	0.8	Vdc

Stage 2 - Dynamic Characteristics ⁽¹⁾

Output Capacitance ($V_{DS} = 28\text{ Vdc} \pm 30\text{ mV(rms)ac}$ @ 1 MHz, $V_{GS} = 0\text{ Vdc}$)	C_{oss}	—	111	—	pF
---	-----------	---	-----	---	----

Functional Tests (In Freescale Test Fixture, 50 ohm system) $V_{DD} = 28\text{ Vdc}$, $I_{DQ1} = 77\text{ mA}$, $I_{DQ2} = 275\text{ mA}$, $P_{out} = 4\text{ W Avg.}$, $f = 2700\text{ MHz}$, WiMAX, OFDM 802.16d, 64 QAM $^{3/4}$, 4 Bursts, 10 MHz Channel Bandwidth, Input Signal PAR = 9.5 dB @ 0.01% Probability on CCDF. ACPR measured in 1 MHz Channel Bandwidth @ $\pm 8.5\text{ MHz}$ Offset.

Power Gain	G_{ps}	25.5	28.5	30.5	dB
Power Added Efficiency	PAE	15	17	—	%
Output Peak-to-Average Ratio @ 0.01% Probability on CCDF	PAR	—	9	—	dB
Adjacent Channel Power Ratio	ACPR	—	-50	-46	dBc
Input Return Loss	IRL	—	-15	-10	dB

Typical Performances OFDM Signal - 10 MHz Channel Bandwidth (In Freescale Test Fixture, 50 ohm system) $V_{DD} = 28\text{ Vdc}$, $I_{DQ1} = 77\text{ mA}$, $I_{DQ2} = 275\text{ mA}$, $P_{out} = 4\text{ W Avg.}$, $f = 2700\text{ MHz}$, WiMAX, OFDM 802.16d, 64 QAM $^{3/4}$, 4 Bursts, 10 MHz Channel Bandwidth, Input Signal PAR = 9.5 dB @ 0.01% Probability on CCDF.

Relative Constellation Error ⁽²⁾	RCE	—	-33	—	dB
Error Vector Magnitude ⁽²⁾	EVM	—	2.2	—	% rms

1. Part internally matched both on input and output.

2. RCE = $20\text{Log}(EVM/100)$

(continued)

Table 5. Electrical Characteristics ($T_A = 25^\circ\text{C}$ unless otherwise noted) (continued)

Characteristic	Symbol	Min	Typ	Max	Unit
Typical Performances (In Freescale Test Fixture, 50 ohm system) $V_{DD} = 28\text{ Vdc}$, $I_{DQ1} = 77\text{ mA}$, $I_{DQ2} = 275\text{ mA}$, 2500-2700 MHz Bandwidth					
P_{out} @ 1 dB Compression Point, CW	P1dB	—	25	—	W
IMD Symmetry @ 27 W PEP, P_{out} where IMD Third Order Intermodulation $\cong 30\text{ dBc}$ (Delta IMD Third Order Intermodulation between Upper and Lower Sidebands $> 2\text{ dB}$)	IMD _{sym}	—	50	—	MHz
VBW Resonance Point (IMD Third Order Intermodulation Inflection Point)	VBW _{res}	—	90	—	MHz
Gain Flatness in 200 MHz Bandwidth @ $P_{out} = 4\text{ W Avg.}$	G_F	—	0.5	—	dB
Average Deviation from Linear Phase in 200 MHz Bandwidth @ $P_{out} = 25\text{ W CW}$	Φ	—	2.1	—	$^\circ$
Average Group Delay @ $P_{out} = 25\text{ W CW}$, $f = 2600\text{ MHz}$	Delay	—	2.3	—	ns
Part-to-Part Insertion Phase Variation @ $P_{out} = 25\text{ W CW}$, $f = 2600\text{ MHz}$, Six Sigma Window	$\Delta\Phi$	—	22	—	$^\circ$
Gain Variation over Temperature (-30°C to $+85^\circ\text{C}$)	ΔG	—	0.036	—	dB/ $^\circ\text{C}$
Output Power Variation over Temperature (-30°C to $+85^\circ\text{C}$)	$\Delta P1\text{dB}$	—	0.003	—	dBm/ $^\circ\text{C}$

Typical Driver Performances (In Freescale Test Fixture, 50 ohm system) $V_{DD} = 28\text{ Vdc}$, $I_{DQ1} = 77\text{ mA}$, $I_{DQ2} = 275\text{ mA}$, $P_{out} = 26\text{ dBm Avg.}$, $f = 2700\text{ MHz}$, WiMAX, OFDM 802.16d, 64 QAM $3/4$, 4 Bursts, 10 MHz Channel Bandwidth, Input Signal PAR = 9.5 dB @ 0.01% Probability on CCDF. ACPR measured in 1 MHz Channel Bandwidth @ $\pm 8.5\text{ MHz}$ Offset.

Power Gain	G_{ps}	—	27.8	—	dB
Power Added Efficiency	PAE	—	3.2	—	%
Output Peak-to-Average Ratio @ 0.01% Probability on CCDF	PAR	—	9	—	dB
Adjacent Channel Power Ratio	ACPR	—	-56	—	dBc
Input Return Loss	IRL	—	-13	—	dB
Relative Constellation Error @ $P_{out} = 1.25\text{ W Avg.}$ (1)	RCE	—	-40	—	dB

1. RCE = $20\text{Log}(EVM/100)$

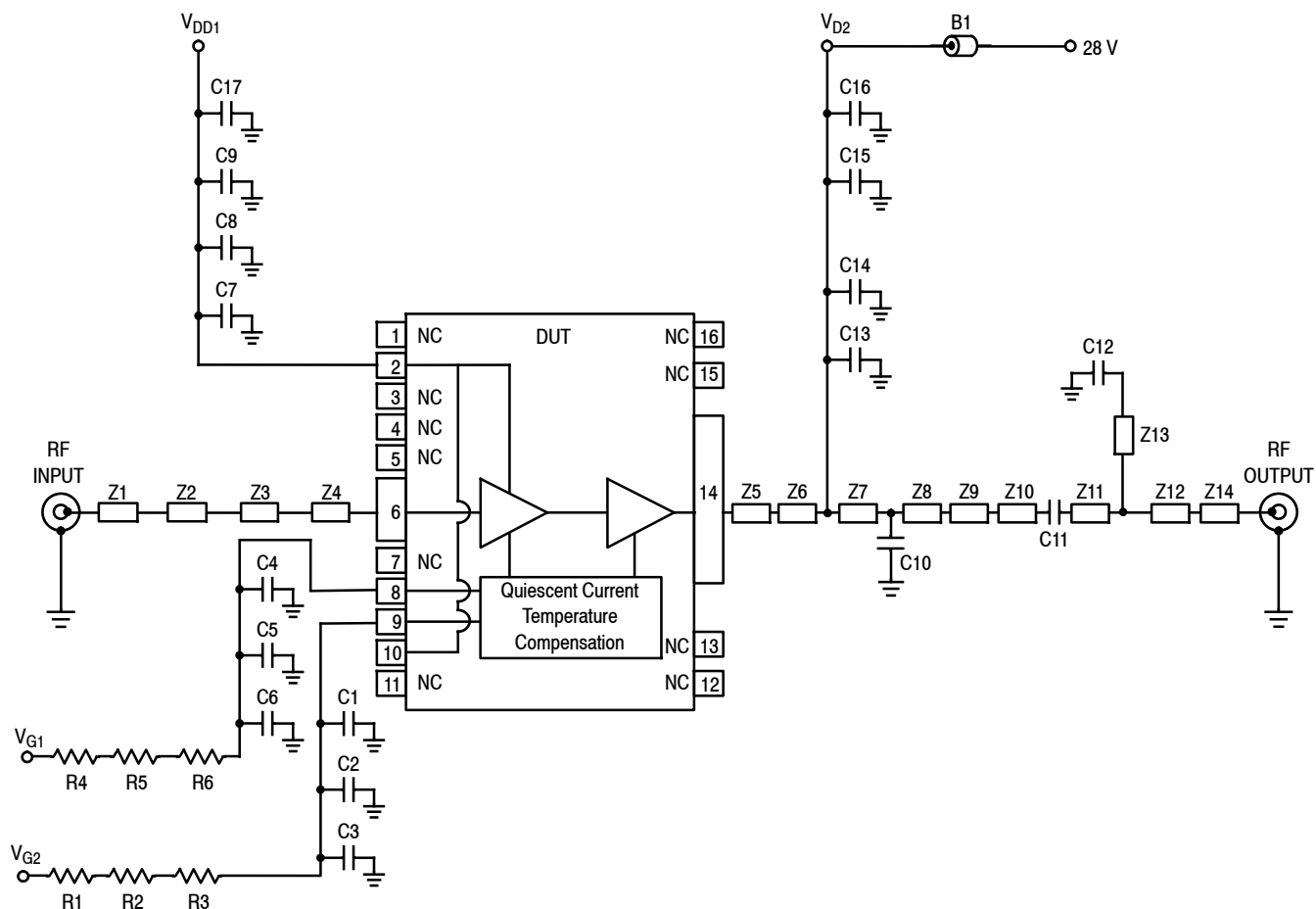

- | | | | |
|----|--------------------------------|------|--|
| Z1 | 0.500" x 0.027" Microstrip | Z9 | 0.040" x 0.061" Microstrip |
| Z2 | 0.075" x 0.127" Microstrip | Z10 | 0.020" x 0.050" Microstrip |
| Z3 | 1.640" x 0.027" Microstrip | Z11 | 0.050" x 0.050" Microstrip |
| Z4 | 0.100" x 0.042" Microstrip | Z12 | 0.050" x 0.027" Microstrip |
| Z5 | 0.151" x 0.268" Microstrip | Z13* | 0.338" x 0.020" Microstrip |
| Z6 | 0.025" x 0.268" x 0.056" Taper | Z14 | 1.551" x 0.027" Microstrip |
| Z7 | 0.050" x 0.056" Microstrip | PCB | Rogers R04350B, 0.0133", $\epsilon_r = 3.48$ |
| Z8 | 0.356" x 0.056" Microstrip | | |
- * Line length includes microstrip bends

Figure 3. MMRF2004NBR1 Test Circuit Schematic

Table 6. MMRF2004NBR1 Test Circuit Component Designations and Values

Part	Description	Part Number	Manufacturer
B1	47 Ω , 100 MHz Short Ferrite Bead	2743019447	Fair-Rite
C1, C4, C7, C12, C15	6.8 pF Chip Capacitors	ATC600S6R8CT250XT	ATC
C2, C5, C8, C13	10 nF Chip Capacitors	C0603C103J5RAC	Kemet
C3, C6, C9, C14	1 μ F, 50 V Chip Capacitors	GRM32RR71H105KA01B	Murata
C10	2.4 pF Chip Capacitor	ATC600S2R4BT250XT	ATC
C11	3.3 pF Chip Capacitor	ATC600S3R3BT250XT	ATC
C16, C17	10 μ F, 50 V Chip Capacitors	GRM55DR61H106KA88B	Murata
R1, R4	12 K Ω , 1/4 W Chip Resistors	CRCW12061202FKEA	Vishay
R2, R3, R5, R6	1 K Ω , 1/4 W Chip Resistors	CRCW12061001FKEA	Vishay

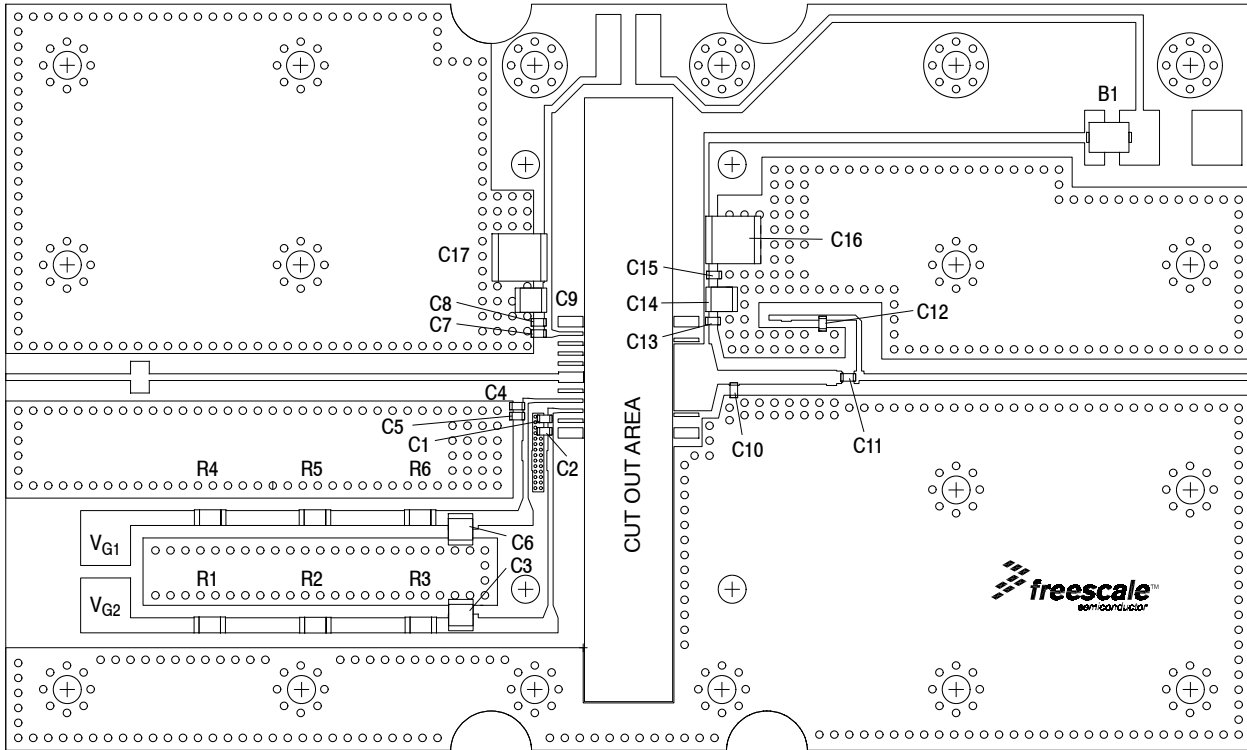

Figure 4. MMRF2004NBR1 Test Circuit Component Layout

TYPICAL CHARACTERISTICS

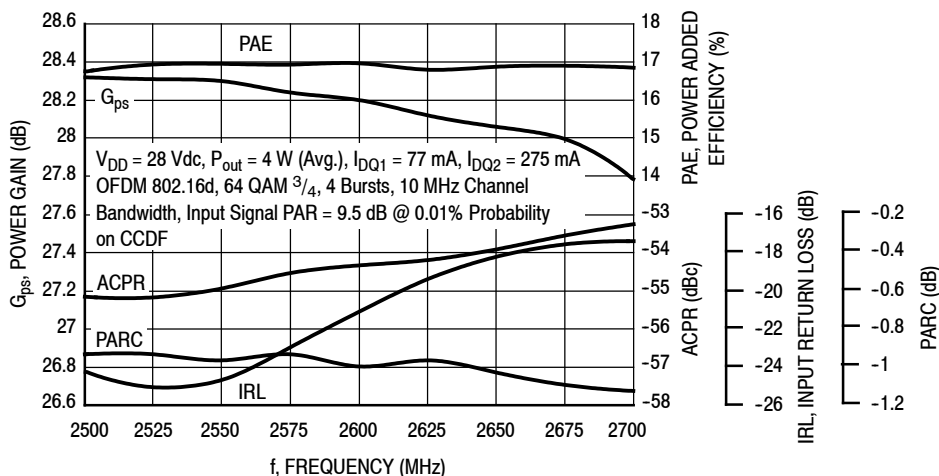

Figure 5. WiMAX Broadband Performance @ $P_{out} = 4$ Watts Avg.

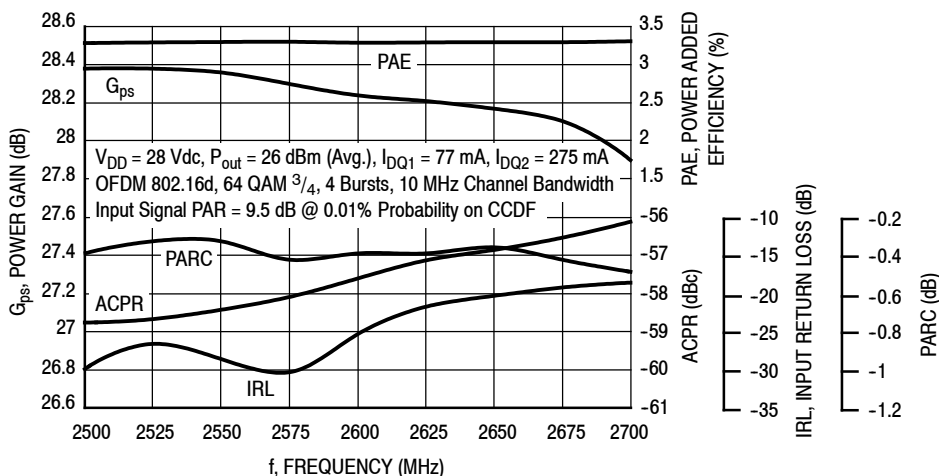

Figure 6. WiMAX Broadband Performance @ $P_{out} = 26$ dBm Avg.

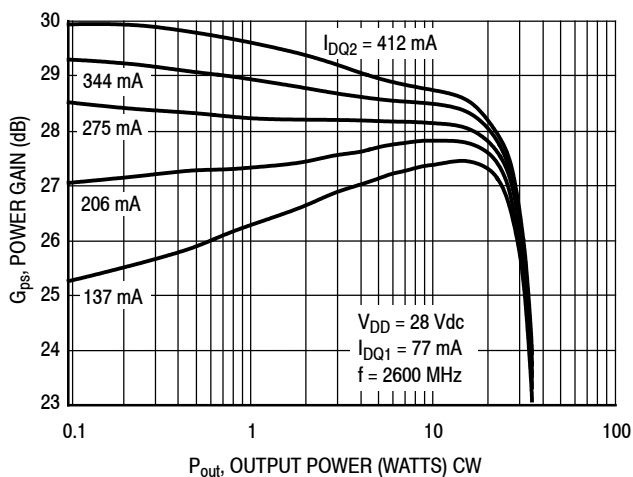

Figure 7. Power Gain versus Output Power @ $I_{DQ1} = 77$ mA

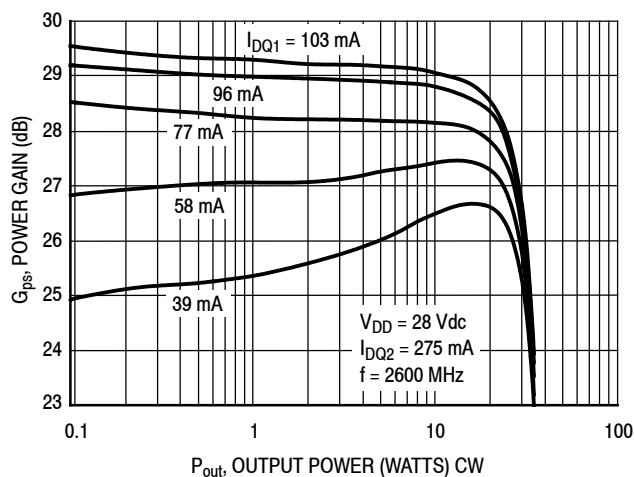

Figure 8. Power Gain versus Output Power @ $I_{DQ2} = 275$ mA

TYPICAL CHARACTERISTICS

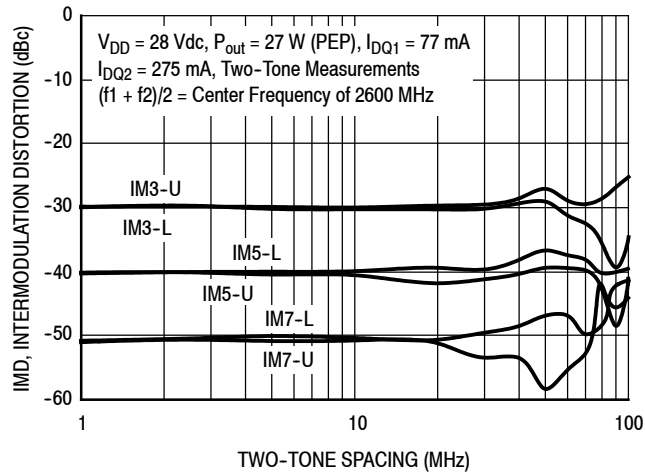

Figure 9. Intermodulation Distortion Products versus Tone Spacing

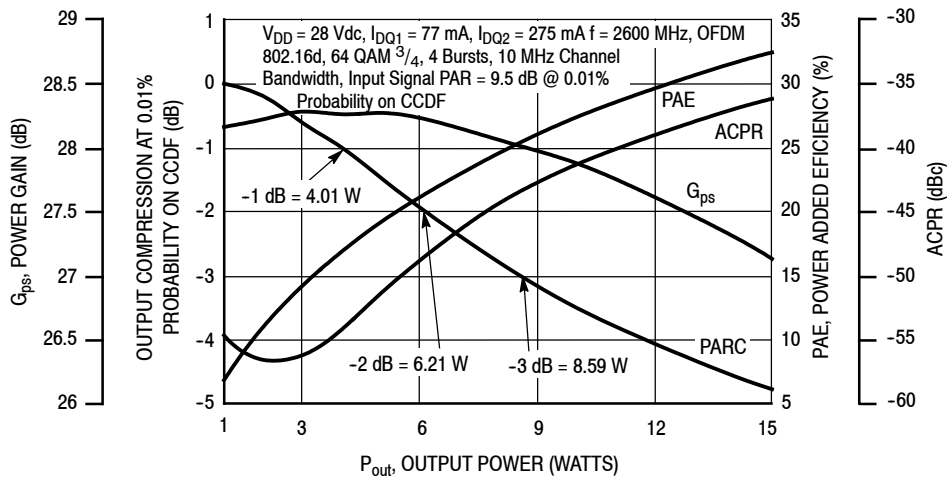

Figure 10. Output Peak-to-Average Ratio Compression (PARC) versus Output Power

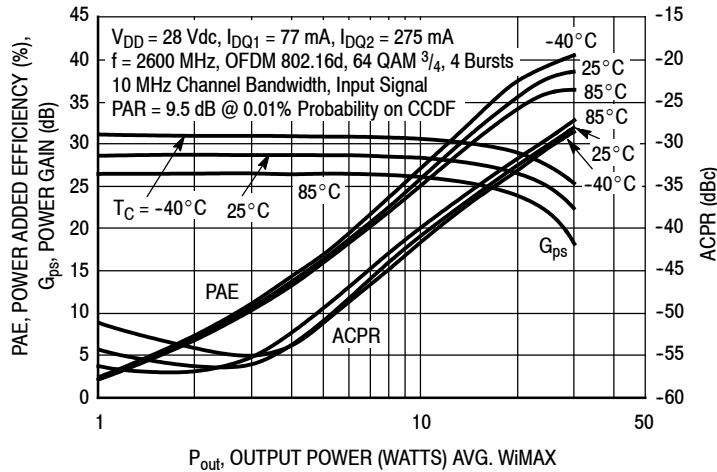

Figure 11. WiMAX, ACPR, Power Gain and Power Added Efficiency versus Output Power

TYPICAL CHARACTERISTICS

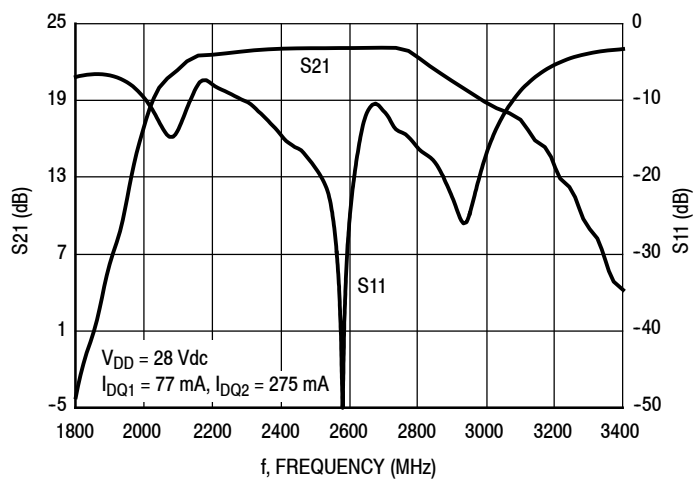

Figure 12. Broadband Frequency Response

WIMAX TEST SIGNAL

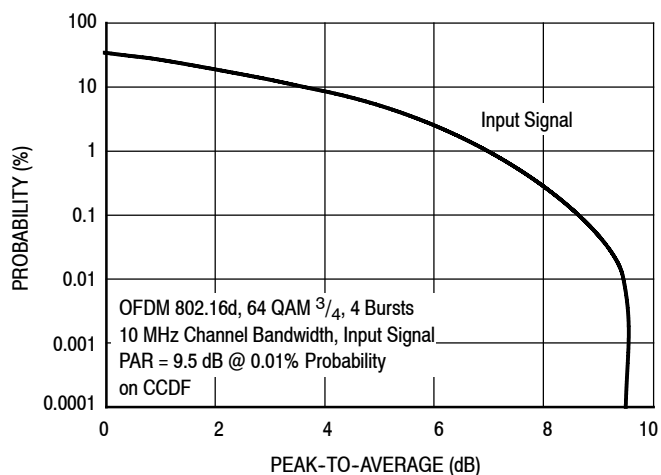

Figure 13. OFDM 802.16d Test Signal

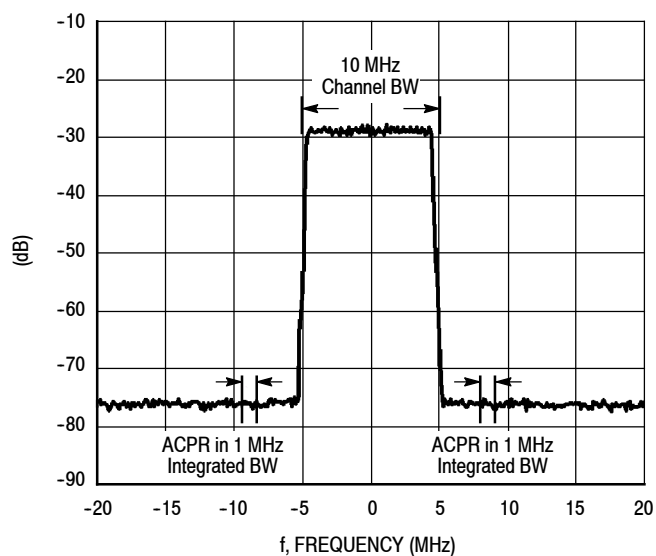
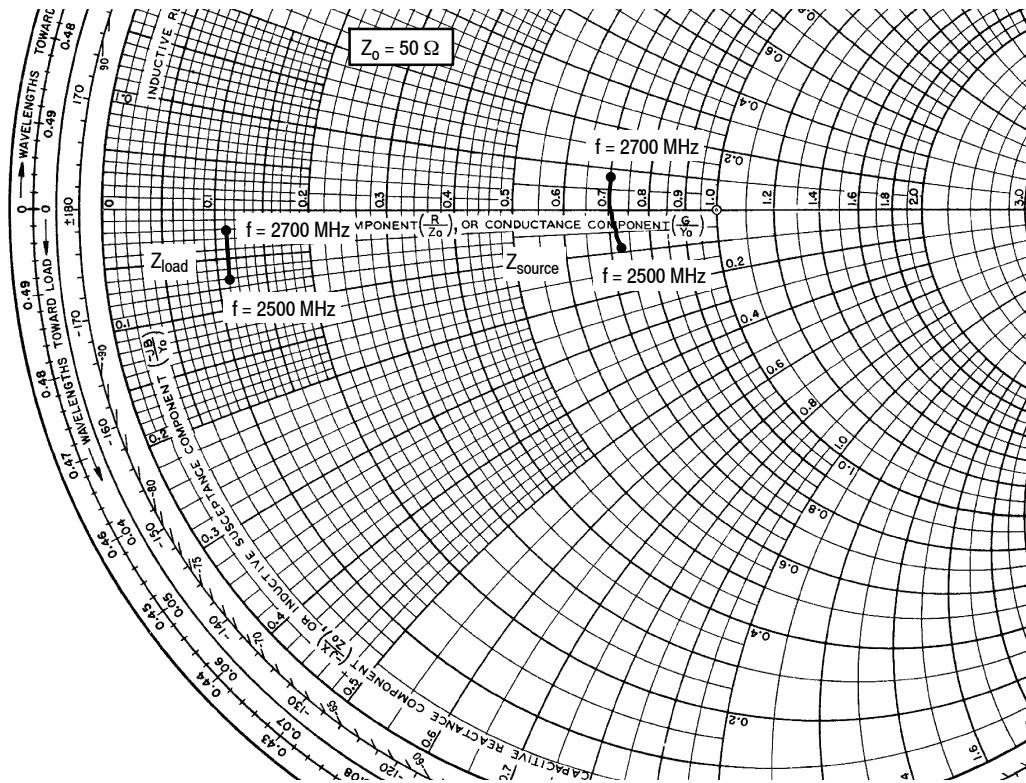

Figure 14. WiMAX Spectrum Mask Specifications



$V_{DD} = 28 \text{ Vdc}$, $I_{DQ1} = 77 \text{ mA}$, $I_{DQ2} = 275 \text{ mA}$, $P_{out} = 4 \text{ W Avg.}$

f MHz	Z_{source} Ω	Z_{load} Ω
2500	$36.381 - j4.271$	$5.717 - j3.618$
2525	$36.041 - j3.328$	$5.624 - j3.187$
2550	$35.753 - j2.363$	$5.578 - j2.770$
2575	$35.516 - j1.380$	$5.589 - j2.412$
2600	$35.333 - j0.381$	$5.586 - j2.088$
2625	$35.203 + j0.635$	$5.579 - j1.807$
2650	$35.126 + j1.664$	$5.552 - j1.559$
2675	$35.104 + j2.707$	$5.564 - j1.335$
2700	$35.138 + j3.760$	$5.568 - j1.164$

Z_{source} = Test circuit impedance as measured from gate to ground.

Z_{load} = Test circuit impedance as measured from drain to ground.

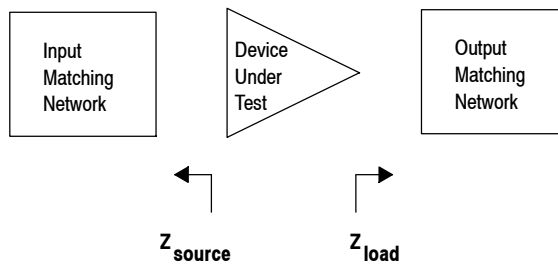

Figure 15. Series Equivalent Source and Load Impedance

Table 7. Common Source S-Parameters ($V_{DD} = 28\text{ V}$, $I_{DQ1} = 77\text{ mA}$, $I_{DQ2} = 275\text{ mA}$, $T_A = 25^\circ\text{C}$, 50 Ohm System)

f MHz	S ₁₁		S ₂₁		S ₁₂		S ₂₂	
	S ₁₁	∠ φ	S ₂₁	∠ φ	S ₁₂	∠ φ	S ₂₂	∠ φ
1500	0.735	61.0	0.001	-167.6	0.000501	26.6	0.992	167.9
1550	0.729	53.3	0.004	-146.0	0.000361	34.7	0.993	166.3
1600	0.715	46.5	0.014	-146.4	0.000114	109.5	0.991	164.6
1650	0.695	39.8	0.039	-152.5	0.000385	148.4	0.992	162.7
1700	0.665	32.9	0.110	-166.8	0.000773	155.6	0.989	160.5
1750	0.619	25.0	0.299	169.4	0.00134	153.2	0.979	157.8
1800	0.549	15.1	0.708	134.4	0.00198	143.0	0.944	155.2
1850	0.452	2.6	1.335	96.3	0.00250	131.2	0.903	153.9
1900	0.332	-14.4	2.195	62.1	0.00290	121.7	0.879	153.0
1950	0.199	-40.1	3.445	32.7	0.00320	113.8	0.847	151.0
2000	0.089	-91.9	5.724	4.8	0.00345	108.5	0.817	147.7
2050	0.078	167.4	10.041	-26.2	0.00382	107.0	0.749	140.6
2100	0.116	90.3	19.072	-65.1	0.00525	105.3	0.571	125.2
2150	0.170	-13.2	32.642	-126.0	0.00781	77.9	0.054	160.2
2200	0.192	-93.2	31.339	171.3	0.00640	41.0	0.555	-144.4
2250	0.177	-123.0	26.174	130.3	0.00432	24.9	0.726	-160.3
2300	0.163	-132.6	23.605	98.7	0.00294	22.3	0.770	-167.1
2350	0.153	-140.5	22.427	70.0	0.00224	31.0	0.789	-170.1
2400	0.119	-153.6	21.922	41.7	0.00208	42.5	0.800	-171.0
2450	0.059	-165.3	21.172	14.2	0.00216	48.9	0.820	-171.2
2500	0.014	-50.7	20.172	-12.5	0.00227	48.9	0.850	-171.3
2550	0.055	-55.0	19.222	-39.5	0.00213	51.4	0.889	-171.7
2600	0.056	-84.7	17.366	-66.8	0.00209	57.8	0.933	-173.2
2650	0.029	177.4	14.562	-91.5	0.00247	65.6	0.961	-175.8
2700	0.069	103.3	12.199	-111.7	0.00286	62.2	0.968	-178.0
2750	0.122	84.1	10.485	-130.4	0.00308	56.3	0.969	-179.5
2800	0.287	59.8	8.086	-154.4	0.00326	50.9	0.969	179.3
2850	0.184	-5.4	7.102	-152.5	0.00292	39.2	0.966	178.6
2900	0.129	-17.4	6.753	-169.3	0.00256	38.6	0.969	178.0
2950	0.128	-41.0	6.107	175.4	0.00232	38.5	0.970	177.4
3000	0.164	-65.7	5.445	160.8	0.00213	39.9	0.972	176.9
3050	0.223	-86.2	4.867	146.7	0.00196	42.0	0.972	176.4
3100	0.297	-100.4	4.363	133.2	0.00183	46.0	0.973	176.0
3150	0.374	-110.4	3.918	120.0	0.00176	51.4	0.974	175.5
3200	0.447	-118.0	3.534	107.2	0.00181	56.5	0.974	174.9
3250	0.515	-123.4	3.198	95.3	0.00191	60.9	0.975	174.3
3300	0.563	-128.0	2.951	83.3	0.00211	58.8	0.975	173.7
3350	0.619	-131.8	2.761	71.2	0.00206	63.0	0.976	173.0
3400	0.651	-136.0	2.581	58.8	0.00218	64.8	0.975	172.3
3450	0.671	-140.1	2.418	46.0	0.00237	68.3	0.975	171.6

(continued)

Table 7. Common Source S-Parameters ($V_{DD} = 28\text{ V}$, $I_{DQ1} = 77\text{ mA}$, $I_{DQ2} = 275\text{ mA}$, $T_A = 25^\circ\text{C}$, 50 Ohm System) (continued)

f MHz	S ₁₁		S ₂₁		S ₁₂		S ₂₂	
	S ₁₁	∠ φ	S ₂₁	∠ φ	S ₁₂	∠ φ	S ₂₂	∠ φ
3500	0.679	-144.4	2.257	32.6	0.00265	68.5	0.974	171.0
3550	0.677	-147.9	2.054	19.2	0.00280	65.0	0.976	170.5
3600	0.661	-153.5	1.851	5.0	0.00281	67.1	0.976	170.0
3650	0.696	-153.8	1.644	-5.8	0.00328	69.3	0.976	169.6
3700	0.721	-161.3	1.453	-19.4	0.00350	65.8	0.977	169.4
3750	0.737	-168.1	1.243	-32.1	0.00357	64.5	0.978	169.2
3800	0.753	-174.7	1.042	-43.7	0.00374	64.5	0.979	169.2
3850	0.771	179.2	0.859	-54.3	0.00401	62.5	0.980	169.2
3900	0.788	174.4	0.708	-62.8	0.00407	58.4	0.980	169.3
3950	0.812	169.8	0.583	-71.5	0.00416	57.7	0.981	169.3
4000	0.829	166.0	0.477	-79.0	0.00427	55.8	0.982	169.3

ALTERNATIVE PEAK TUNE LOAD PULL CHARACTERISTICS

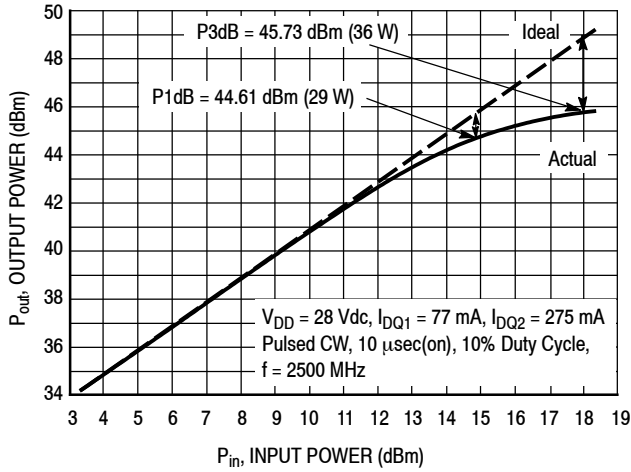

NOTE: Load Pull Test Fixture Tuned for Peak P1dB Output Power @ 28 V

Test Impedances per Compression Level

	Z_{source} Ω	Z_{load} Ω
P1dB	$42.7 + j11.6$	$4.86 - j1.63$

Figure 16. Pulsed CW Output Power versus Input Power @ 28 V @ 2500 MHz

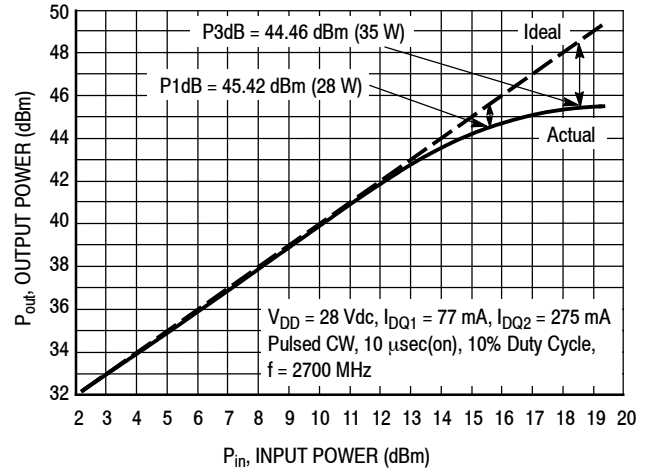

NOTE: Load Pull Test Fixture Tuned for Peak P1dB Output Power @ 28 V

Test Impedances per Compression Level

	Z_{source} Ω	Z_{load} Ω
P1dB	$39.5 - j8.7$	$3.53 - j1.66$

Figure 17. Pulsed CW Output Power versus Input Power @ 28 V @ 2700 MHz

PACKAGE DIMENSIONS

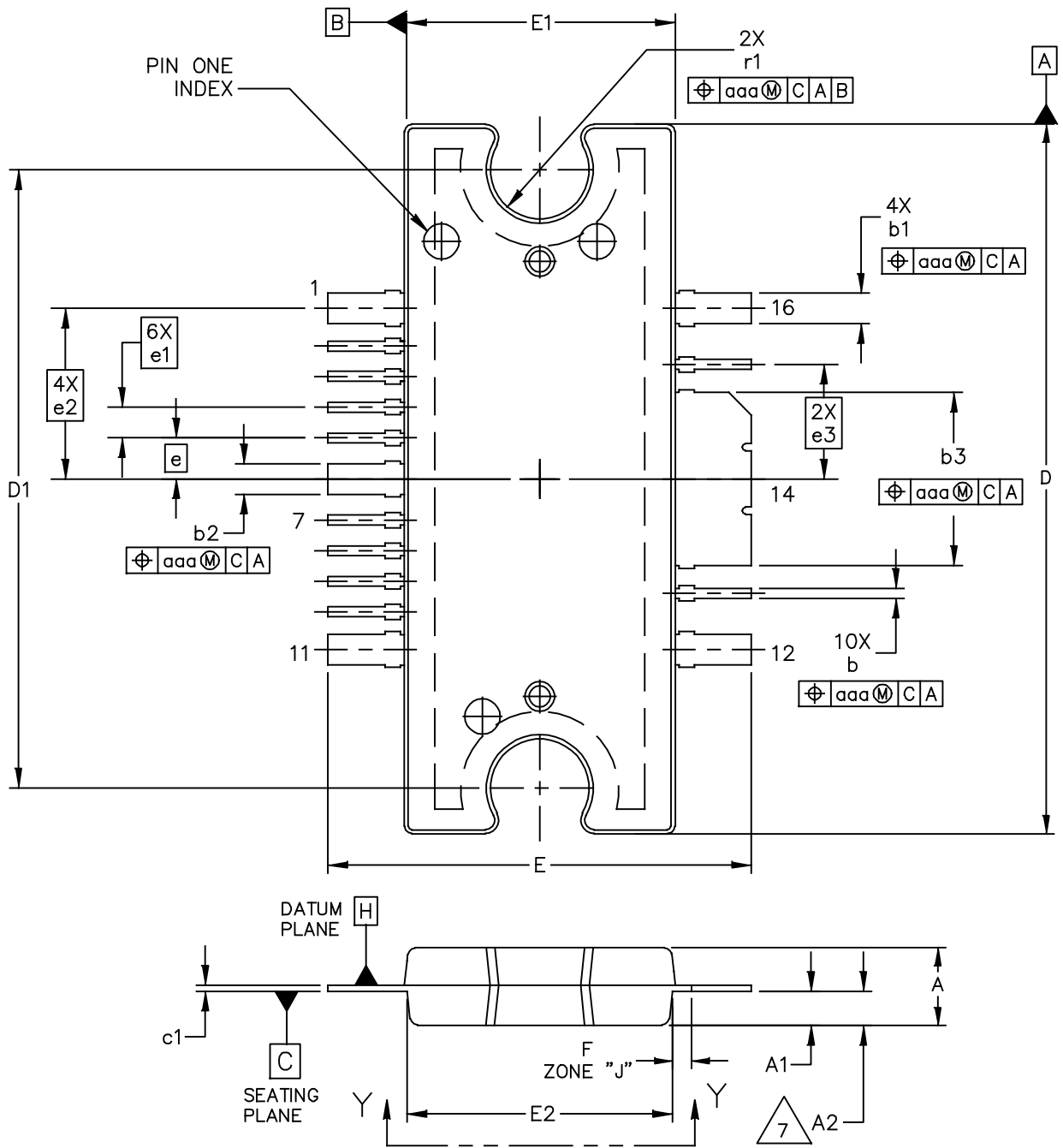

© FREESCALE SEMICONDUCTOR, INC. ALL RIGHTS RESERVED.		MECHANICAL OUTLINE	PRINT VERSION NOT TO SCALE
TITLE: TO-272 WIDE BODY MULTI-LEAD	DOCUMENT NO: 98ARH99164A		REV: P
	CASE NUMBER: 1329-09		18 MAY 2010
	STANDARD: NON-JEDEC		

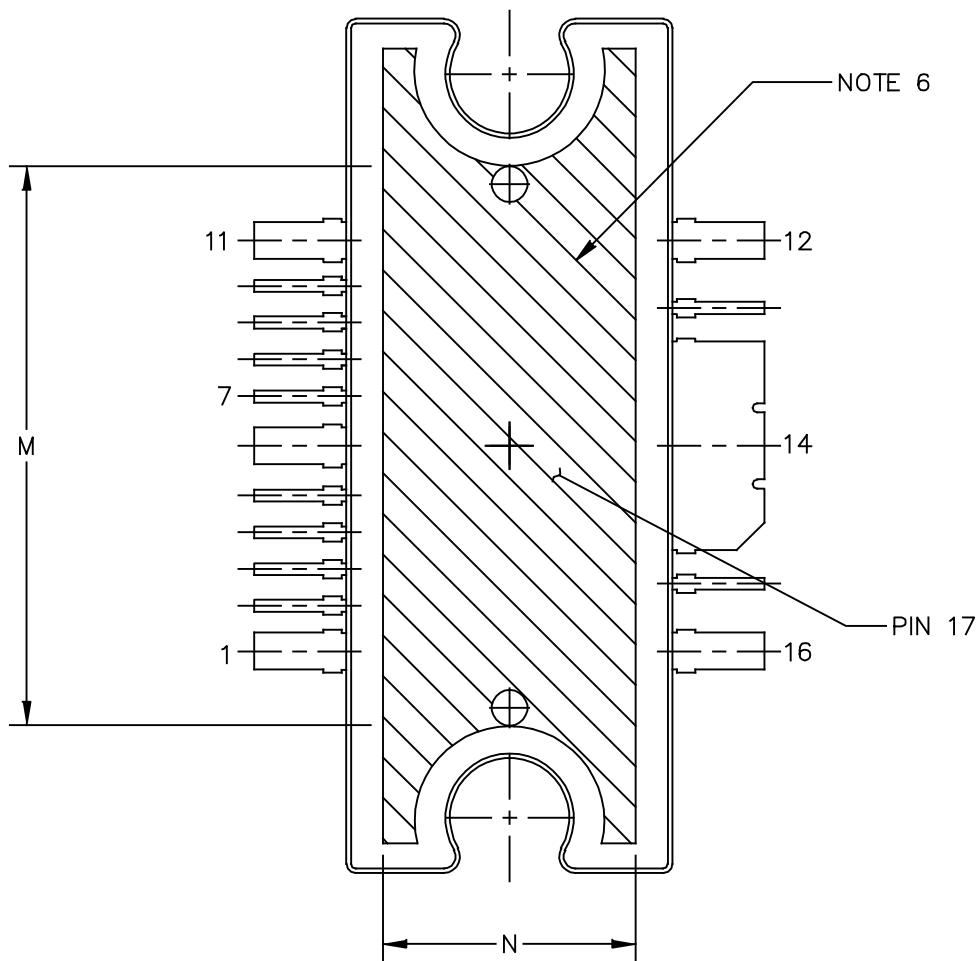

VIEW Y-Y

© FREESCALE SEMICONDUCTOR, INC. ALL RIGHTS RESERVED.	MECHANICAL OUTLINE	PRINT VERSION NOT TO SCALE	
TITLE: TO-272 WIDE BODY MULTI-LEAD	DOCUMENT NO: 98ARH99164A	REV: P	
	CASE NUMBER: 1329-09	18 MAY 2010	
	STANDARD: NON-JEDEC		

NOTES:

1. CONTROLLING DIMENSION: INCH
2. INTERPRET DIMENSIONS AND TOLERANCES PER ASME Y14.5M-1994.
3. DATUM PLANE -H- IS LOCATED AT THE TOP OF LEAD AND IS COINCIDENT WITH THE LEAD WHERE THE LEAD EXITS THE PLASTIC BODY AT THE TOP OF THE PARTING LINE.
4. DIMENSIONS "D" AND "E1" DO NOT INCLUDE MOLD PROTRUSION. ALLOWABLE PROTRUSION IS .006 (0.15) PER SIDE. DIMENSIONS "D" AND "E1" DO INCLUDE MOLD MISMATCH AND ARE DETERMINED AT DATUM PLANE -H-.
5. DIMENSIONS "b", "b1", "b2" AND "b3" DO NOT INCLUDE DAMBAR PROTRUSION. ALLOWABLE DAMBAR PROTRUSION SHALL BE .005 (0.13) TOTAL IN EXCESS OF THE "b", "b1", "b2" AND "b3" DIMENSIONS AT MAXIMUM MATERIAL CONDITION.
6. HATCHING REPRESENTS THE EXPOSED AREA OF THE HEAT SLUG. HATCHED AREA SHOWN IS ON THE SAME PLANE.
7. DIM A2 APPLIES WITHIN ZONE "J" ONLY.

DIM	INCH		MILLIMETER		DIM	INCH		MILLIMETER	
	MIN	MAX	MIN	MAX		MIN	MAX	MIN	MAX
A	.100	.104	2.54	2.64	b	.011	.017	0.28	0.43
A1	.038	.044	0.96	1.12	b1	.037	.043	0.94	1.09
A2	.040	.042	1.02	1.07	b2	.037	.043	0.94	1.09
D	.928	.932	23.57	23.67	b3	.225	.231	5.72	5.87
D1	.810 BSC		20.57 BSC		c1	.007	.011	.18	.28
E	.551	.559	14.00	14.20	e	.054 BSC		1.37 BSC	
E1	.353	.357	8.97	9.07	e1	.040 BSC		1.02 BSC	
E2	.346	.350	8.79	8.89	e2	.224 BSC		5.69 BSC	
F	.025 BSC		0.64 BSC		e3	.150 BSC		3.81 BSC	
M	.600	----	15.24	----	r1	.063	.068	1.6	1.73
N	.270	----	6.86	----	aaa	.004		.10	
© FREESCALE SEMICONDUCTOR, INC. ALL RIGHTS RESERVED.			MECHANICAL OUTLINE			PRINT VERSION NOT TO SCALE			
TITLE: TO-272 WIDE BODY MULTI-LEAD					DOCUMENT NO: 98ARH99164A			REV: P	
					CASE NUMBER: 1329-09			18 MAY 2010	
					STANDARD: NON-JEDEC				

PRODUCT DOCUMENTATION

Refer to the following documents to aid your design process.

Application Notes

- AN1955: Thermal Measurement Methodology of RF Power Amplifiers
- AN1977: Quiescent Current Thermal Tracking Circuit in the RF Integrated Circuit Family
- AN1987: Quiescent Current Control for the RF Integrated Circuit Device Family
- AN3263: Bolt Down Mounting Method for High Power RF Transistors and RFICs in Over-Molded Plastic Packages

Engineering Bulletins

- EB212: Using Data Sheet Impedances for RF LDMOS Devices

REVISION HISTORY

The following table summarizes revisions to this document.

Revision	Date	Description
0	Dec. 2013	• Initial Release of Data Sheet

How to Reach Us:

Home Page:
freescale.com

Web Support:
freescale.com/support

Information in this document is provided solely to enable system and software implementers to use Freescale products. There are no express or implied copyright licenses granted hereunder to design or fabricate any integrated circuits based on the information in this document.

Freescale reserves the right to make changes without further notice to any products herein. Freescale makes no warranty, representation, or guarantee regarding the suitability of its products for any particular purpose, nor does Freescale assume any liability arising out of the application or use of any product or circuit, and specifically disclaims any and all liability, including without limitation consequential or incidental damages. "Typical" parameters that may be provided in Freescale data sheets and/or specifications can and do vary in different applications, and actual performance may vary over time. All operating parameters, including "typicals," must be validated for each customer application by customer's technical experts. Freescale does not convey any license under its patent rights nor the rights of others. Freescale sells products pursuant to standard terms and conditions of sale, which can be found at the following address: freescale.com/SalesTermsandConditions.

Freescale and the Freescale logo are trademarks of Freescale Semiconductor, Inc., Reg. U.S. Pat. & Tm. Off. All other product or service names are the property of their respective owners.

© 2013 Freescale Semiconductor, Inc.